

COMPRESSED AIR FILTERS

DESCRIPTION	PRESSURE RANGE	CONNECTION	SERIES	PAGE
	bar	thread		
bronze In-Line-Filter	21	G $\frac{1}{4}$ - G $\frac{1}{2}$	137	16.02
In-Line-Filter 0,3 μ m	9	nipple \varnothing 4. 6 mm	F400	16.02
„Miniature“-Series	21	G $\frac{1}{8}$ and G $\frac{1}{4}$	F504	16.03
made of plastic	16	G $\frac{1}{8}$ - G1	F035 ... F095	16.04
made of plastic, with FDA-approval	10	G $\frac{1}{8}$ - G $\frac{3}{4}$	FH	16.06
„Maxi“-Series, robust, block design	17	G $\frac{1}{2}$ - G1	F20	16.07
made of brass, many variations	50	G $\frac{1}{8}$ - G2	FM	16.08
„Standard“-Series, robust	21	G $\frac{3}{4}$ - G2	F602	16.10
Series „D“, made of aluminium	30	G $\frac{1}{8}$ - G2	FD	16.12
3 μ m pre-filter	16	G $\frac{1}{4}$ - G3	FG.V	16.14
1 μ m fine filter	16	G $\frac{1}{4}$ - G3	FG.Z	16.14
0.01 μ m fine filter	16	G $\frac{1}{4}$ - G3	FG.X	16.15
activated carbon filter	16	G $\frac{1}{4}$ - G3	FG.A	16.15
high pressure filter, also for oxygen	60	G $\frac{3}{8}$ - G2	F445, F465	16.16
filter silencer	16	G $\frac{1}{4}$ - G2	SFE	16.17



16

Micro in-line filter F400

Description Micro in-line filters are widely used in medical and process technology for cleaning compressed air for use in instruments and pneumatic logic systems. The micro in-line filter removes particles, oil and mist from compressed air. Also suitable for vacuum.

Filter element The borosilicate micro-filter is manufactured in a special vacuum process which reduces the adhesive properties of the borosilicate fibres down to a minimum in order to achieve outstanding filtering capability. When saturated with oil, the filter turns red to indicate that replacement is required.

Filtration efficiency 99.999% based on 0.03 µm particle size

Operating pressure max. 9 bar

Connection Fitted with nipples able to take up hoses of 4.3 mm (11/16") or 6.3 mm (¼") internal diameter. Flow direction from INside to OUTside to be noted.

Bronze in-line filter 137

Description Bronze in-line filter for compressed air with coarse impurities.

Filter element 90 µm, 20 µm or optionally 5 µm, made of sintered bronze

Operating pressure max. 21 bar

Drainage with or without manual drain

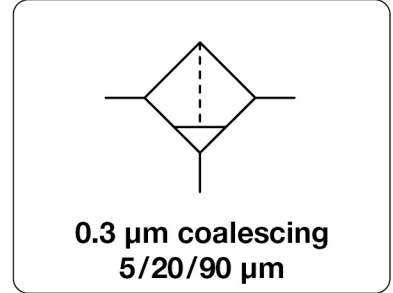

Dimensions			Description	Flow rate		P ₁ max. bar	Filter element µm	Connection thread	Order number
A	B	C		m ³ /h*1	l/min*1				

Micro in-line filter			99.999% at 0.3 µm, discolouration at saturation, max. 9 bar				F400		
87	43	Ø 27	borosilicate-micro filter	4.2	70	9	0.3	Ø 4 and Ø 6	F400



F400

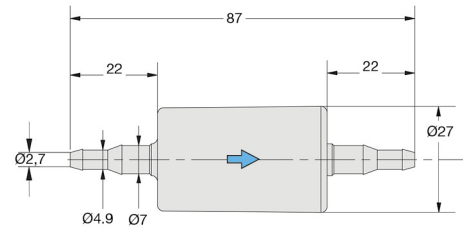

F400

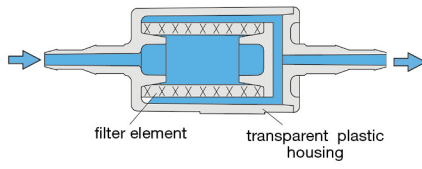

cross section

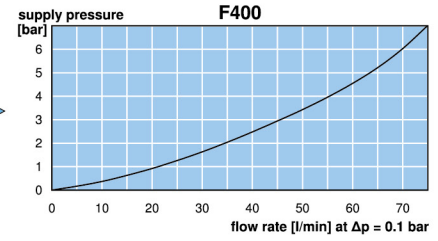

Bronze in-line filter			operating pressure max. 21 bar				137		
67	63	32	without manual drain	39	650	21	90	G¼	137-02
				42	700	G¾	137-03		
				44	740	G½	137-04		
			with manual drain	39	650	21	20	G¼	137-02H
				42	700	G¾	137-03H		
				44	740	G½	137-04H		
67	79	48	without manual drain	19	320	21	5	G¼	137-02V
				21	350	G¾	137-03V		
				22	370	G½	137-04V		
			with manual drain	39	650	21	90	G¼	137-02A
				42	700	G¾	137-03A		
				44	740	G½	137-04A		
with manual drain	39	650	21	20	G¼	137-02AH			
	42	700	G¾	137-03AH					
	44	740	G½	137-04AH					
with manual drain	19	320	21	5	G¼	137-02AV			
	21	350	G¾	137-03AV					
	22	370	G½	137-04AV					



137-04



137-04A

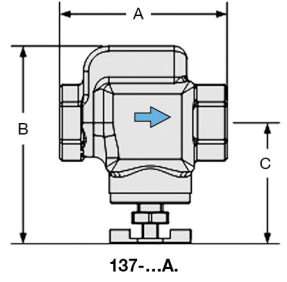
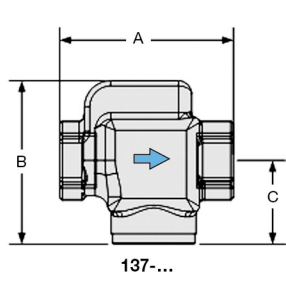

*1 at 7 bar operating pressure and 0.1 bar pressure drop

Description	Miniature compressed air filter of small, compact design. Ideal for limited space conditions.
Filter element	20 µm, optionally 5 µm, made of polypropylene
Bowl	plastic or metal version
Drainage	manual drain as standard, for max. 21 bar optionally semiautomatic drain, for max. 12 bar
Operating pressure	max. 11 bar for plastic bowl max. 21 bar for metal bowl
Temperature range	0 °C to 50 °C / 32 °F to 122 °F for plastic bowl and semiautomatic drain version 0 °C to 80 °C / 32 °F to 176 °F for metal bowl for appropriately conditioned compressed air down to -30 °C / -22 °F
Material	Body: aluminium Bowl: polyurethane or zinc die-cast Elastomer: NBR/Buna-N

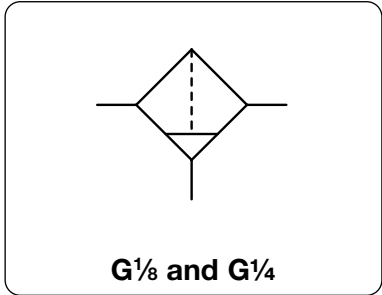

Dimensions			Bowl	Flow	Supply	Filter	Connection	Order
A	B	C	Design	Capacity	rate	element	thread	number
mm	mm	mm	made of	l	m ³ /h*1	l/min*1	bar	µm

Miniature compressed air filter				with manual drain	F504					
40	106	96	plastic	0.04	36	600	11	20	G ¹ / ₈	F504-01AH
			metal				21			F504-01DH
			plastic		29	480	11	5		F504-01AG
			metal				21			F504-01DG
40	106	96	plastic	0.04	38	640	11	20	G ¹ / ₄	F504-02AH
			metal				21			F504-02DH
			plastic		31	510	11	5		F504-02AG
			metal				21			F504-02DG



Special options, add the appropriate letter

NPT	connection thread	F504-... N
semiautomatic drain	RK500SY, max. 12 bar	F504-... M
automatic drain	RK504SY, max. 12 bar	F504-... R

Accessories, enclosed

mounting bracket	made of steel	BW00-01
-------------------------	---------------	----------------

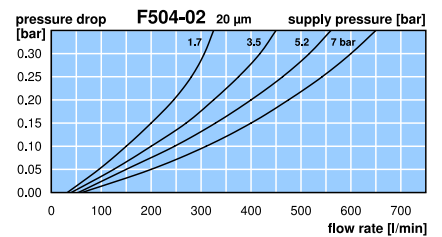
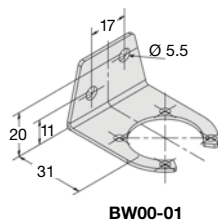
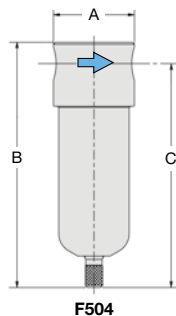

*1 at 7 bar operating pressure and 0.33 bar pressure drop

Extensions: see chapter for FRL service units

PDF CAD
www.aircom.net

Order example:
F504-01AH

Description	Filter of modular design which can be interlocked with all other instruments of the same series without need for double nipples. The flow on standard filters is from outside to inside; on coalescing filters 0.1 µm from inside to outside.	
Filter element	5 µm, 20 µm, 80 µm made of sintered polyethylene, 160 µm made of stainless steel, 0.01 µm coalescing filter made of borosilicate and activated carbon filter	
Filtration efficiency	coalescing filter: 99.99% at 0.01 µm particle size,	residual oil content < 5 mg/m³
Bowl	plastic version with bayonet catch,	type 042 with connection thread
Drainage	manual drain in conjunction with semiautomatic drain, optionally automatic drain, no drain for water	
Operating pressure	max. 7 bar at series 035, max. 16 bar at series 042, max. 12.5 bar at series 050 to 095	
Temperature range	0 °C to 50 °C / 32 °F to 122 °F	
Material	Body: nylon, POM at types 035 and 042 Bowl: polyamide	Elastomer: NBR/Buna-N Inner valve: brass

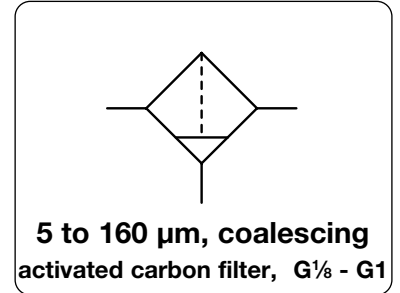

Dimensions			Bowl	Flow	P ₁	Filter	Connection	Order
A	B	C	Design	Capacity	rate	max.	element	thread
mm	mm	mm		l	m³/h*1	l/min*1	µm	G

Compressed air filter			manual drain with semiautomatic drain, 99.99% at 0.01 µm				F0			
38	79	67	plastic	0.008	45	750	7	20	G ¹ / ₈	F035-01H
			plastic		40	670		5		F035-01G
			for water w/o drain		50	830		80		F035-01J
			coalescing		7	115		0.01		F035-01C
42	146	126	plastic	0.02	75	1250	16	20	G ¹ / ₄	F042-02H
			plastic		63	1050		5		F042-02G
			for water w/o drain		79	1320		80		F042-02J
			for water w/o drain		87	1450		160		F042-02K
			coalescing		11	180		0.01		F042-02C
			plastic		87	1450		activated carbon		F042-02A
52	174	148	bowl guard	0.04	150	2500	12.5	20	G ³ / ₈	F050-03H
					126	2100		5		F050-03G
					16	500		0.01		F050-03C
					150	2500		activated carbon		F050-03A

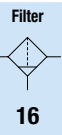

Series	D	ØE	F	K	L
F035	8.5	3.5	20	-	36
F042	10.5	4.5	31	-	42
F050	16.0	5.5	41	63	52

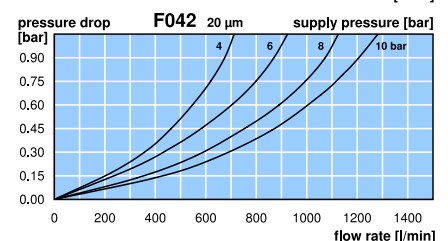
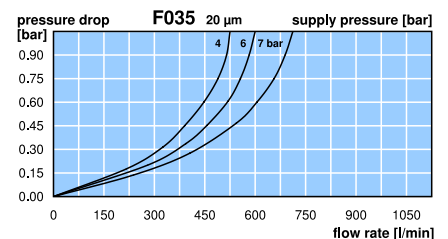
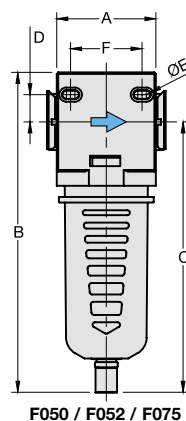
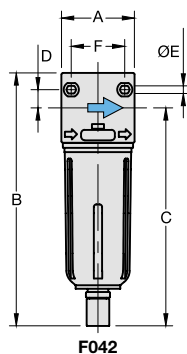
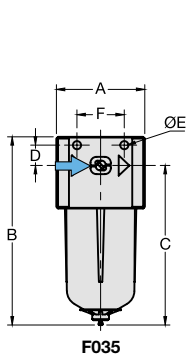
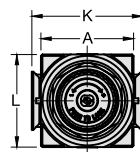

*1 at 10 bar operating pressure and 1 bar pressure drop, for F035 and filter element 0.01 µm only 7 bar operating pressure

Extensions: see chapter for FRL service units

PDF CAD
www.aircom.net



Order example:
F035-01H

COMPRESSED AIR FILTER MADE OF PLASTIC

F035 ... F095

Description	Filter of modular design which can be interlocked with all other instruments of the same series without need for double nipples. The flow on standard filters is from outside to inside; on coalescing filters 0.1 µm from inside to outside.	
Filter element	5 µm, 20 µm, 80 µm made of sintered polyethylene, 160 µm made of stainless steel, 0.01 µm coalescing filter made of borosilicate and activated carbon filter	
Filtration efficiency	coalescing filter: 99.99% at 0.01 µm particle size,	residual oil content < 5 mg/m ³
Bowl	plastic version with bayonet catch,	type 042 with connection thread
Drainage	manual drain in conjunction with semiautomatic drain, optionally automatic drain, no drain for water	
Operating pressure	max. 7 bar at series 035, max. 16 bar at series 042, max. 12.5 bar at series 050 to 095	
Temperature range	0 °C to 50 °C / 32 °F to 122 °F	
Material	Body: nylon, POM at types 035 and 042 Bowl: polyamide	Elastomer: NBR/Buna-N Inner valve: brass

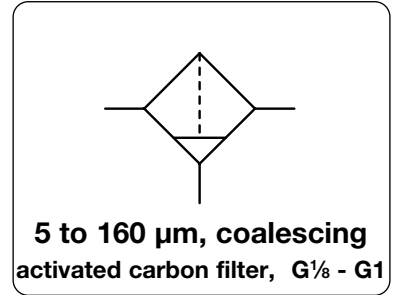

Dimensions			Bowl	Flow	P ₁	Filter	Connection	Order
A	B	C	Design	Capacity	rate	max.	element	thread
mm	mm	mm		l	m ³ /h*1	l/min*1	µm	G

Compressed air filter			manual drain with semiautomatic drain, 99.99% at 0.01 µm				F0			
52	174	148	bowl guard	0.04	156	2600	12.5	20	G ¹ / ₂	F052-04H
					132	2200		5		F052-04G
					17	500		0.01		F052-04C
					156	2600		activated carbon		F052-04A
63	204	173	bowl guard	0.10	186	3100	12.5	20	G ¹ / ₂	F075-04H
					165	2750		5		F075-04G
					18	800		0.01		F075-04C
					186	3100		activated carbon		F075-04A
137	204	173	bowl guard	0.10	192	3200	12.5	20	G ³ / ₄	F080-06H
					168	2800		5		F080-06G
					18	800		0.01		F080-06C
95	284	237	bowl guard	0.20	828	13800	12.5	20	G ¹	F095-08H
					750	12500		5		F095-08G



Special options, add the appropriate letter

automatic drain C400200130 for F042 to F095 F0 . . 0 . . R

Accessories, enclosed

mounting bracket set made of steel for F095 **BW00-02**

Series	D	Ø E	F	K	L
F052	16.0	5.5	41	63	52
F075	17.5	5.5	45	75	63
F080	17.5	5.5	45	-	63
F095	-	-	-	115	95

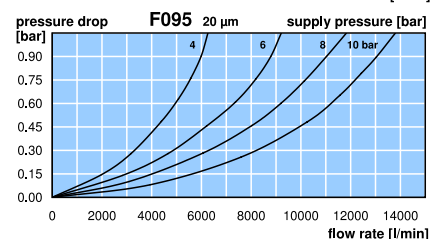
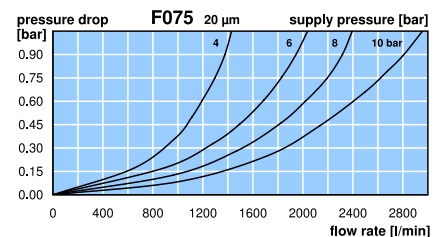
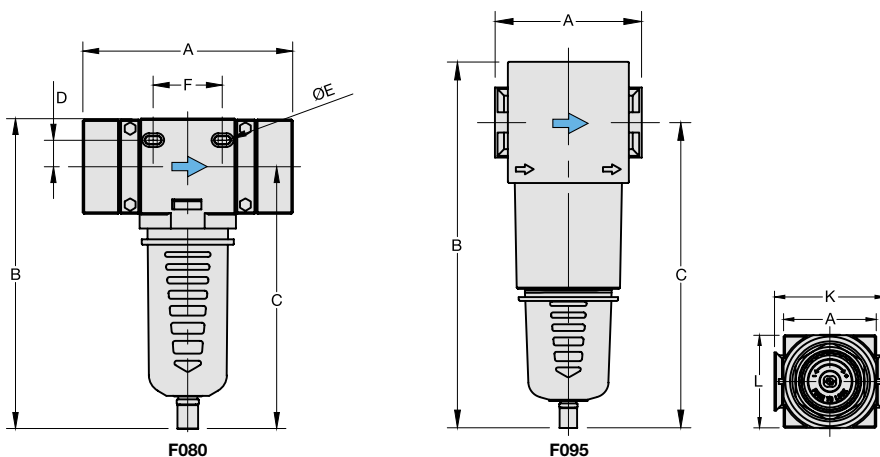

*1 at 10 bar operating pressure and 1 bar pressure drop, for F035 and filter element 00.1 µm only 7 bar operating pressure

Extensions: see chapter for FRL service units

PDF CAD
www.aircom.net



Order example:
F052-04H

Description	Filter made of plastic for compressed air, vacuum, non-corrosive gases or liquids. The flow on the filter elements passes from outside to inside. They are largely corrosion-resistant and feature excellent chemical stability. Exposure of the filters to direct sunlight must be avoided. Optionally available with EPDM elastomers approved by the FDA.		
Filter element	5 µm, 35 µm and 80 µm made of PE, 50 µm, 100 µm and 300 µm made of stainless steel		
Bowl	made of transparent Grilamid TR55, three different sizes, screwable, without drain		
Drainage	without drain, as no water separation occurs with compressed air		
Operating pressure	max. 10 bar at 20 °C / 68 °F	Differential pressure	max. 0.7 bar
Temperature range	5 °C to 50 °C / 41 °F to 122 °F		
Cleaning	with lukewarm water and standard rinsing agent		
Material	Body: polypropylene Bowl: polyester, transparent	Filter element: polyethylene, optionally stainless steel Elastomer: NBR/Buna-N, optionally FKM or EPDM (FDA)	

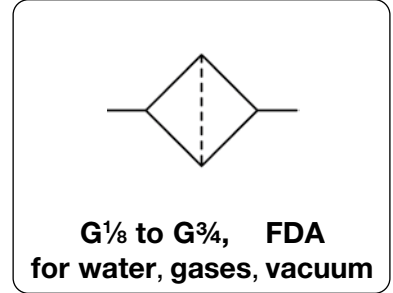

Dimensions			Bowl Capacity	Flow rate		Filter element	Connection thread	Order number
A	B	C	l	Water l/min*1	Air l/min*1	µm	G	

Plastic filter			operating pressure differential pressure max. 10 bar max. 0.7 bar	max. 10 bar max. 0.7 bar		NBR/Buna-N o-ring polyamide, polypropylene	FH
58	93	83	0.06	6	140	5	G ¹ / ₈ FH1-01G FH1-01J FH1-01L
					180	35	
					200	80	
74	95	85	0.06	8	180	5	G ¹ / ₄ FH1-02G FH1-02J FH1-02L
					230	35	
					300	80	
74	99	87	0.06	10	220	5	G ³ / ₈ FH1-03G FH1-03J FH1-03L
					280	35	
					300	80	
75	103	89	0.06	12	260	5	G ¹ / ₂ FH1-04G FH1-04J FH1-04L
					330	35	
					350	80	
90	124	112	0.17	14	400	5	G ³ / ₈ FH2-03G FH2-03J FH2-03L
					500	35	
					520	80	
90	128	113	0.17	16	480	5	G ¹ / ₂ FH2-04G FH2-04J FH2-04L
					600	35	
					620	80	
90	133	116	0.17	18	560	5	G ³ / ₄ FH2-06G FH2-06J FH2-06L
					700	35	
					720	80	

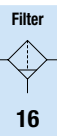

Special options, add the appropriate letter

with short bowl *2	shorter filter element,	4 l/min water	FH1 only	FH0-...
SST filter element	metallic tissue 50 µm S;	100 µm T;	300 µm	FH0-...U FH1-...U FH2-...U FH...E FH...V
EPDM elastomer	FDA approved			
FKM elastomer				

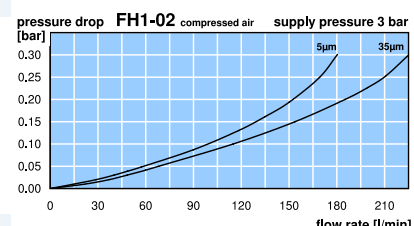

Accessories, enclosed

mounting bracket	made of plastic	for FH0 and FH1 for FH2	BW17-01 BW17-02
-------------------------	-----------------	----------------------------	----------------------------------

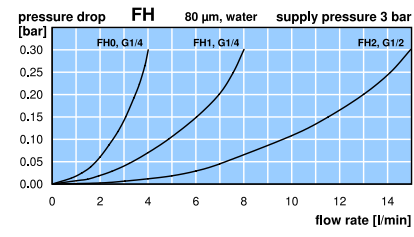
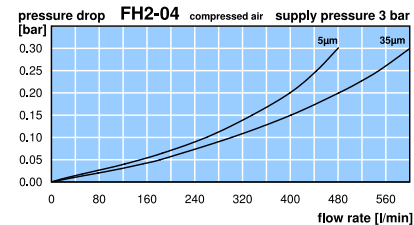
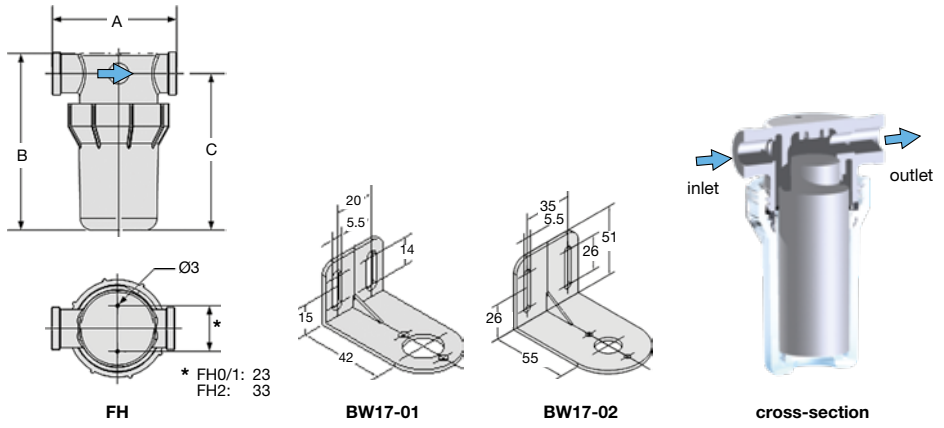

*1 at 3 bar operating pressure and 0.3 bar pressure drop
*2 flow reduced by 35%, height shortened by 35 mm, bowl capacity 0.014 l

Description	Compressed air filter of modular design with exchangeable inserts. Can be interlocked with regulator or lubricator without need for double nipples. Each "maxi" device may be taken from a fixed line in seconds by simply removing the mounting bolts.
Filter element	40 µm, optionally 5 µm, made of polypropylene
Bowl	metal version with sight glass
Drainage	manual drain as standard, optionally automatic or semiautomatic drain, for max. 12 bar
Operating pressure	max. 17 bar
Temperature range	0 °C to 70 °C / 32 °F to 158 °F 0 °C to 50 °C / 32 °F to 122 °F for automatic or semiautomatic drain version
Material	Body: zinc die-cast Sight glass: polyurethane Bowl: zinc die-cast Elastomer: NBR/Buna-N

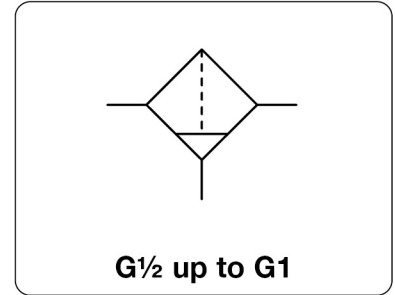

Dimensions			Bowl	Flow	Supply	Filter	Connection	Order
A	B	C	Design	Capacity	rate	max. element	thread	number
mm	mm	mm	made of / with	l	m³/h*1	l/min*1	bar	µm

"Maxi" compressed air filter									with manual drain supply pressure max. 17 bar	F20
89	191	171	metal/sight glass	0.3	288	4800		40	G½	F20-04WJ
					216	3600		5		F20-04WG
111	191	171	metal/sight glass	0.3	408	6800	17	40	G¾	F20-06WJ
					294	4900		5		F20-06WG
					420	7000		40	G1	F20-08WJ
					300	5000		5		F20-08WG



Special options, add the appropriate letter

NPT	connection thread	F20-0 .W .N
semiautomatic drain	RK500SY, max. 12 bar	F20-0 .W .M
automatic drain	SA605MD, max. 12 bar	F20-0 .W .R

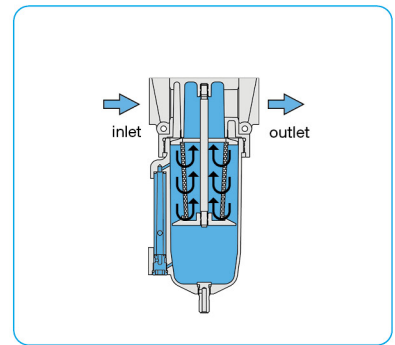

Accessories, enclosed

mounting bracket set	made of steel	MK20-0100
-----------------------------	---------------	------------------

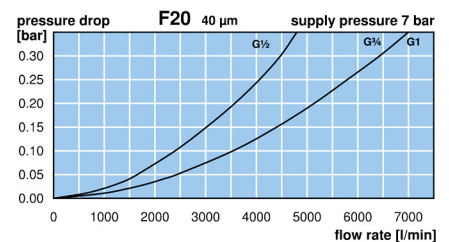
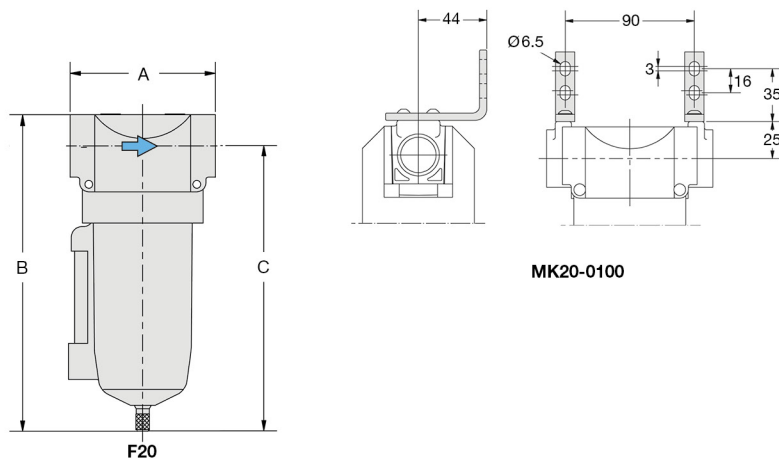

*1 at 7 bar supply pressure and 0.33 bar pressure drop

Extensions: see chapter for FRL service units

PDF CAD
www.aircom.net



Order example:
F20-04WJ

COMPRESSED AIR FILTER MADE OF BRASS, UP TO 50 BAR

FM

Description	Filter with bowl without sight glass, extremely robust, for compressed air, non-corrosive gases or liquids.
Filter element	50 µm, optionally 5 µm, made of stainless steel Bowl stainless steel version without sight glass
Drainage	screw plug as standard optionally for compressed air only: manual drain (max. 30 bar), automatic drain (max. 16 bar)
Operating pressure	max. 50 bar (without drain), optionally manual drain (max. 30 bar) or automatic drain (max. 16 bar)
Temperature range	0 °C to 80 °C / 32 °F to 140 °F, for FKM or EPDM, 0 °C to 130 °C / 32 °F to 266 °F, for high temperature version, for appropriately conditioned compressed air down to -20 °C / -4 °F or low temperature version down to -40 °C / -40 °F
Material	Body: brass Bowl: stainless steel 316L, material no 1.4404, brass at FM-01/-A2 Elastomer: FKM, optionally EPDM Inner valve: brass and plastic (not at high temperature version)

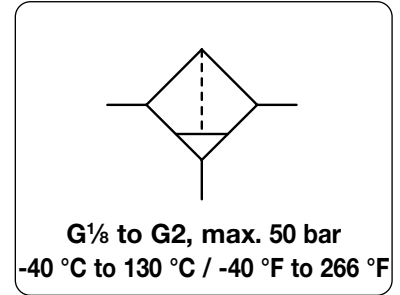

Dimensions			Bowl	Flow	Supply	Filter	Connection	Order
A	B	C	Design	Capacity	rate	element	thread	number
mm	mm	mm	made of	l	m ³ /h*1	µm	G	

Brass filter			with screw plug, operating pressure max. 50 bar, 50 µm				FM		
40	92	81	brass	0.03	45	750	50	G ¹ / ₈	FM-01 FM-01G
40	92	81	brass	0.03	45	750	50	G ¹ / ₄	FM-A2 FM-A2G
64	140	125	stainless steel	0.14	54	900	50	G ¹ / ₄	FM-02 FM-02G FM-02I
64	140	125	stainless steel	0.14	60	1000	50	G ³ / ₈	FM-03 FM-03G FM-03I
79	150	130	stainless steel	0.20	150	2500	50	G ¹ / ₂	FM-04 FM-04G FM-04I
136	194	167	stainless steel	0.50	432	7200	50	G ³ / ₄	FM-06 FM-06G FM-06I
136	194	167	stainless steel	0.50	432	7200	50	G1	FM-08 FM-08G FM-08I
247	194	167	stainless steel	0.50	432	7200	50	G ¹ / ₄	FM-10 FM-10G FM-10I
247	194	167	stainless steel	0.50	432	7200	50	G ¹ / ₂	FM-1A FM-1AG FM-1AI
174	248	213	stainless steel	1.00	1380	23000	50	G ¹ / ₂	FM-12 FM-12G
174	248	213	stainless steel	1.00	1380	23000	50	G2	FM-16 FM-16G

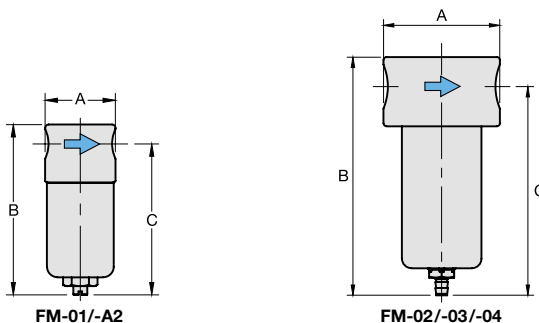
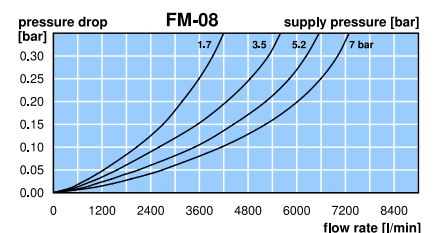
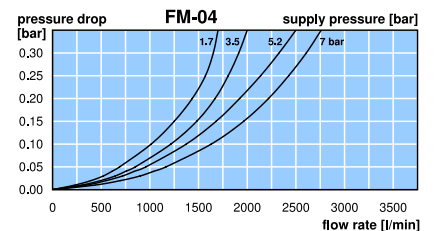
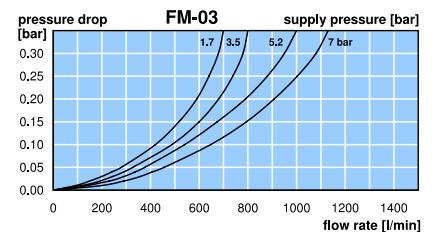

*1 at 7 bar operating pressure and 0.33 bar pressure drop

Extensions: see chapter for FRL service units

PDF CAD
www.aircom.net

Order example:
FM-01

Description	Filter with bowl without sight glass, extremely robust, for compressed air, non-corrosive gases or liquids.		
Filter element	50 µm, optionally 5 µm, made of stainless steel	Bowl	stainless steel version without sight glass
Drainage	screw plug as standard optionally for compressed air only: manual drain (max. 30 bar), automatic drain (max. 16 bar)		
Operating pressure	max. 50 bar (without drain), optionally manual drain (max. 30 bar) or automatic drain (max. 16 bar)		
Temperature range	0 °C to 80 °C / 32 °F to 140 °F, for FKM or EPDM, 0 °C to 130 °C / 32 °F to 266 °F, for high temperature version, for appropriately conditioned compressed air down to -20 °C / -4 °F or low temperature version down to -40 °C / -40 °F		
Material	Body: brass Bowl: stainless steel 316L, material no 1.4404, brass at FM-01/-A2 Elastomer: FKM, optionally EPDM Inner valve: brass and plastic (not at high temperature version)		

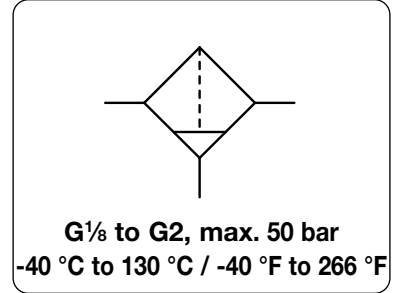

Dimensions			Bowl	Flow	Supply	Filter	Connection	Order
A	B	C	Design	Capacity	rate	element	thread	number
mm	mm	mm	made of	l	m ³ /h*1	l/min*1	µm	G

Special options, add the appropriate letter

NPT	connection thread		FM-..N
P1: max. 80 bar		for G ¹ / ₄ (02)	FM-..X48
down to -40 °C	low temperature version		FM-..X51
u p to 130 °C	high temperature version		FM-..X54
manual drain	max. 30 bar		FM-..H
automatic drain	made of SST, max. 16 bar	for G ¹ / ₄ (02)	FM-..R
EPDM-elastomer			FM-..E
carbon dioxide	CO ₂		FM-..03
argon	Ar		FM-..05
nitrogen	N ₂		FM-..07
helium	He		FM-..09
hydrogen	H ₂		FM-..11
methane	CH ₄		FM-..13
oxygen	O ₂		FM-..15
propane	C ₃ H ₈		FM-..16
nitrous oxide	N ₂ O		FM-..17
for water	50 µm only	for G ¹ / ₄ (02) to G2	FM-..W
flange connection	see chapter for stainless steel devices / flanges		FM-..F.

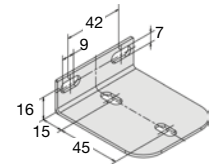

BW00-17S

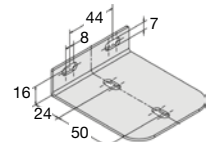

BW00-18S

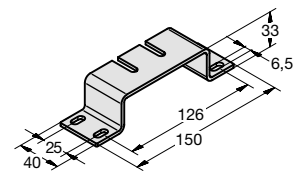

BW00-59S

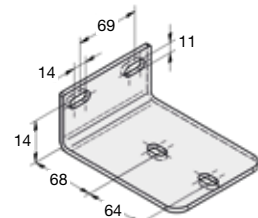

BW00-63S



Accessories, enclosed

mounting bracket	made of stainless steel	for G ¹ / ₄ (02) and G ³ / ₈ for G ¹ / ₂	BW00-17S BW00-18S
set of brackets	made of stainless steel	for G ³ / ₄ to G1 ¹ / ₂ (1A) for G1 ¹ / ₂ (12) and G2	BW00-19S BW00-63S

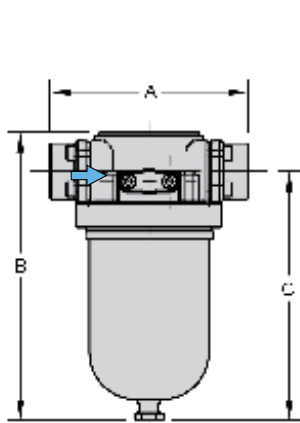

FM-06/-08/-10/-1A

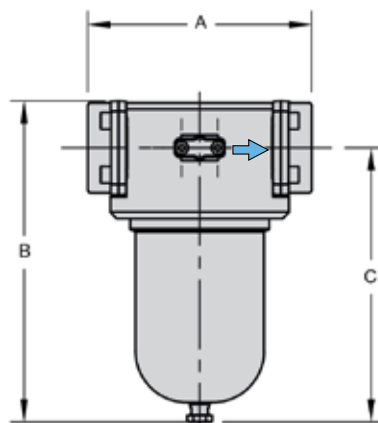

FM-12/-16

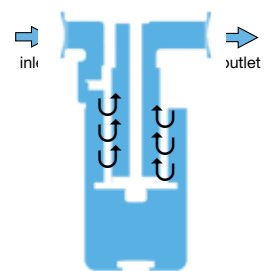

cross-section

*1 at 7 bar operating pressure and 0.33 bar pressure drop

Extensions: see chapter for FRL service units

PDF CAD
www.aircom.net



Order example:
BW00-17S

STANDARD COMPRESSED AIR FILTER

F602

Description	Compressed air filter with high flow. Made of solid design and small size. Proven in operation and suitable for many applications. Available in all standard sizes and in many versions.		
Filter element	40 µm, optionally 5 µm, made of polypropylene		
Bowl	metal version with or without bowl guard		
Drainage	manual drain as standard, for max. 21 bar optionally internal automatic drain, for max. 12 / 16 bar or external automatic drain, for max. 18 bar		
Operating pressure	max. 17 bar for metal bowl with sight glass max. 21 bar for metal bowl without sight glass		
Temperature range	0 °C to 50 °C / 32 °F to 122 °F for automatic drain version 0 °C to 70 °C / 32 °F to 158 °F for metal bowl with sight glass 0 °C to 80 °C / 32 °F to 176 °F for metal bowl without sight glass for appropriately conditioned compressed air down to -30 °C / -22 °F		
Material	Body: zinc die-cast	Bowl: zinc die-cast or steel	Elastomer: NBR/Buna-N

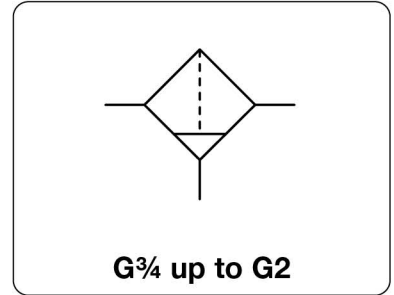

Dimensions			Bowl	Flow	Supply	Filter	Connection	Order
A	B	C	Design	rate	max.	element	thread	number
mm	mm	mm	made of / with	m ³ /h*1	l/min*1	µm	G	

Standard compressed air filter			with manual drain			F602				
116	223	200	metal / sight glass	0.50	426	7100	17	40	G ^{3/4} *2	F602-06WJ
116	295	272	steel	1.00			21			F602-06EJ
116	223	200	metal / sight glass	0.50	318	5300	17	5	G ^{3/4} *2	F602-06WG
116	295	272	steel	1.00			21			F602-06EG
116	223	200	metal / sight glass	0.50	588	9800	17	40	G1	F602-08WJ
116	295	272	steel	1.00			21			F602-08EJ
116	223	200	metal / sight glass	0.50	438	7300	17	5	G1	F602-08WG
116	295	272	steel	1.00			21			F602-08EG
132	242	210	metal / sight glass	0.5	660	11000	17	40	G1 ^{1/4} *2	F602-10WJ
132	315	283	steel	1.0			21			F602-10EJ
132	242	210	metal / sight glass	0.5	492	8200	17	5	G1 ^{1/4} *2	F602-10WG
132	315	283	steel	1.0			21			F602-10EG



F602-06WJ/-08WJ
metal bowl with sight glass



F602-10WJ/-12WJ
metal bowl with sight glass

Filter
16

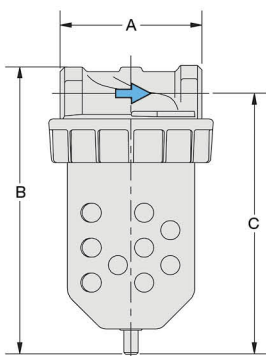

F602

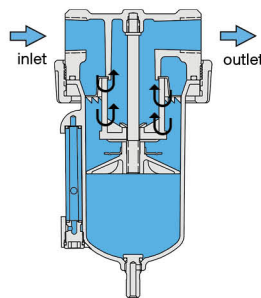

cross-section

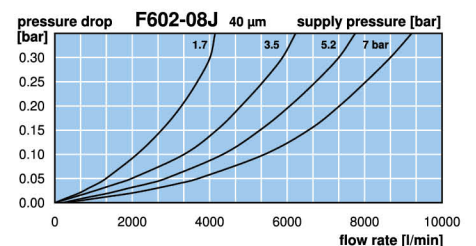

*1 at 7 bar operating pressure and 0.33 bar pressure drop

*2 reduced by the next larger filter

Extensions: see chapter for FRL service units

PDF CAD
www.aircom.net



Order example:
F602-06WJ

STANDARD COMPRESSED AIR FILTER

F602

Description	Compressed air filter with high flow. Made of solid design and small size. Proven in operation and suitable for many applications. Available in all standard sizes and in many versions.		
Filter element	40 µm, optionally 5 µm, made of polypropylene		
Bowl	metal version with or without bowl guard		
Drainage	manual drain as standard, for max. 21 bar optionally internal automatic drain, for max. 12 / 16 bar or external automatic drain, for max. 18 bar		
Operating pressure	max. 17 bar for metal bowl with sight glass max. 21 bar for metal bowl without sight glass		
Temperature range	0 °C to 50 °C / 32 °F to 122 °F for automatic drain version 0 °C to 70 °C / 32 °F to 158 °F for metal bowl with sight glass 0 °C to 80 °C / 32 °F to 176 °F for metal bowl without sight glass for appropriately conditioned compressed air down to -30 °C / -22 °F		
Material	Body: zinc die-cast	Bowl: zinc die-cast or steel	Elastomer: NBR/Buna-N

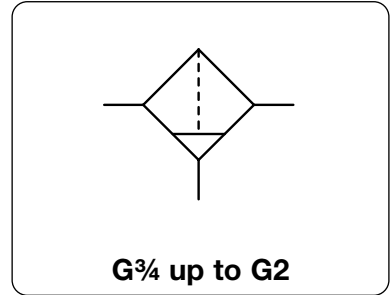

Dimensions			Bowl	Flow	Supply	Filter	Connection	Order
A	B	C	Design	Capacity	rate	element	thread	number
mm	mm	mm	made of / with	l	m ³ /h*1 l/min*1	µm	G	

Standard compressed air filter								with manual drain	F602	
132	242	210	metal / sight glass	0.5	660	11 000	17	40	G1½	F602-12WJ
132	315	283	steel	1.0			21			F602-12EJ
132	242	210	metal / sight glass	0.5	492	8 200	17	5	G1½	F602-12WG
132	315	283	steel	1.0			21			F602-12EG
160	330	281	metal / sight glass	0.5	1740	29 000	17	40	G2	F602-16WJ
160	407	358	steel	1.0			21			F602-16EJ
160	330	281	metal / sight glass	0,5	1800	30 000	17	40	G2½	F602-20WJ
160	407	358	steel	1,0			21			F602-20EJ



F602-10EJ/-12EJ
with steel container

Special options, add the appropriate letter

automatic drain	SA605MD, SA602D, SA603D for steel bowl, SA702MD,	max. 12 bar for G ^{3/4} to G2½ max. 18 bar for G ^{3/4} to G2½ max. 16 bar for G ^{3/4} to G2½	F602-....R F602-....Q F602-....W F602-....F.
flange connection	see chapter for stainless steel devices / flanges		



F602-16WJF
with connecting flange



RK602SY

SA605MD

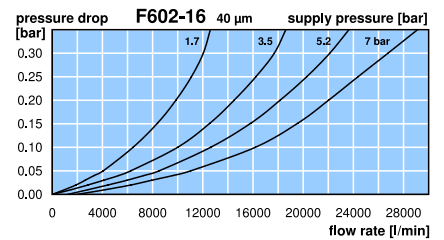
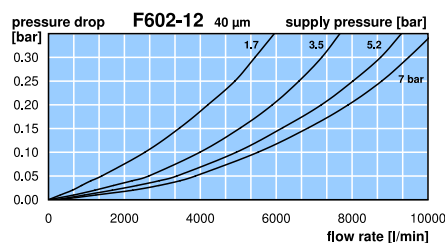

*1 at 7 bar operating pressure and 0.33 bar pressure drop

Extensions: see chapter for FRL service units

PDF CAD
www.aircom.net



Order example:
F602-12WJ

Description	Good value aluminium regulator of solid design.
Filter element	0.01 µm coalescing filter (to -04), 5 µm and 50 µm
Filtration efficiency	coalescing filter: 99.99% based on 0.01 µm particle size
Bowl	metal version with and without sight glass
Drainage	semiautomatic drain as standard, for max. 16 bar optionally manual drain, for max. 30 bar or automatic drain, for max. 16 bar
Operating pressure	max. 16 bar for metal bowl with sight glass max. 30 bar for metal bowl without sight glass
Temperature range	-10 °C to 50 °C / 14 °F to 122 °F for metal bowl with sight glass (-01 to -04 / -12 / -16) -20 °C to 60 °C / -4 °F to 140 °F for metal bowl with sight glass (-06 to -1A) -30 °C to 80 °C / -22 °F to 176 °F for metal bowl without sight glass
Material	Body: aluminium Bowl: aluminium Elastomer: NBR/Buna-N

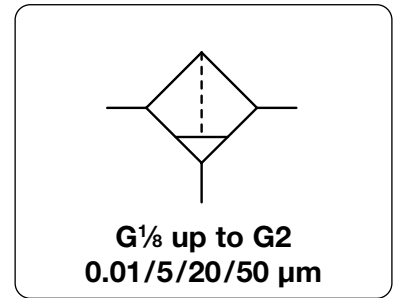

Dimensions			Bowl	Flow	Supply	Filter	Connection	Order
A	B	C	Design	Capacity	rate	element	thread	number
mm	mm	mm	made of/with	l	m ³ /h*1	µm	G	

Compressed air filter series "D"							with semiautomatic drain, 99.99 % at 0.01 µm	FD		
40	145	127	metal/sight glass	0.05	21	350	16	50	G ¹ / ₈	FD-01MJ
					16	270	16	5		FD-01MG
				metal/sight glass	0.05	4	70	16		0.01
40	145	127	metal/sight glass	0.05	24	400	16	50	G ¹ / ₄	FD-02MJ
					18	300	16	5		FD-02MG
				metal/sight glass	0.05	4	70	16		0.01
64	176	148	metal/sight glass	0.18	144	2400	16	50	G ³ / ₈	FD-03MJ
					108	1800	16	5		FD-03MG
				metal/sight glass	0.18	27	450	16		0.01
64	176	148	metal/sight glass	0.18	156	2600	16	50	G ¹ / ₂	FD-04MJ
					120	2000	16	5		FD-04MG
				metal/sight glass	0.18	30	500	16		0.01
130	205	177	metal/sight glass	0.50	420	7000	16	50	G ³ / ₄	FD-06MJ
					318	5300	16	5		FD-06MG
130	205	177	metal/sight glass	0.50	510	8500	16	50	G1	FD-08MJ
					384	6400	16	5		FD-08MG

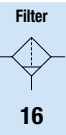

Type	D	Ø E
FD-01/02	30	4.5
FD-03/04	51	5.5

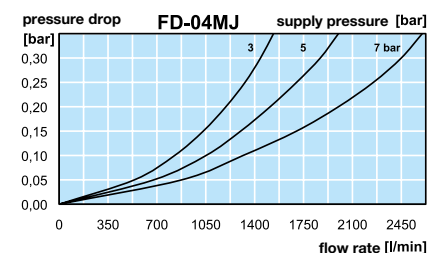
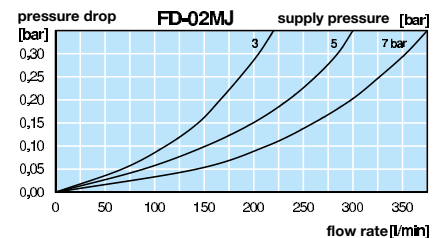
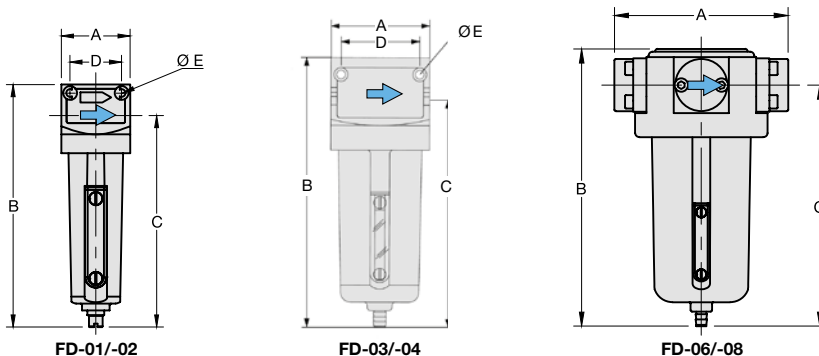

*1 at 7 bar operating pressure and 0.33 bar pressure drop

Extensions: see chapter for FRL service units

PDF CAD
www.aircom.net

Order example:
FD-01MH

COMPRESSED AIR FILTER SERIES "D", UP TO 30 BAR

FD

Description	Good value aluminium regulator of solid design.
Filter element	0.01 µm coalescing filter (to -04), 5 µm and 50 µm
Filtration efficiency	coalescing filter: 99.99% based on 0.01 µm particle size
Bowl	metal version with and without sight glass
Drainage	semiautomatic drain as standard, for max. 16 bar optionally manual drain, for max. 30 bar or automatic drain, for max. 16 bar
Operating pressure	max. 16 bar for metal bowl with sight glass max. 30 bar for metal bowl without sight glass
Temperature range	-10 °C to 50 °C / 14 °F to 122 °F for metal bowl with sight glass (-01 to -04 / -12 / -16) -20 °C to 60 °C / -4 °F to 140 °F for metal bowl with sight glass (-06 to -1A) -30 °C to 80 °C / -22 °F to 176 °F for metal bowl without sight glass
Material	Body: aluminium Bowl: aluminium Elastomer: NBR/Buna-N

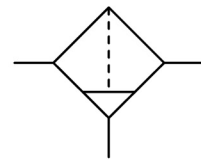

G¹/₈ up to G2
0.01/5/20/50 µm

Dimensions			Bowl	Flow	Supply	Filter	Connection	Order
A	B	C	Design	Capacity	rate	element	thread	number
mm	mm	mm	made of/with	l	m ³ /h*1	µm	G	

Compressed air filter series "D"								with semiautomatic drain, 99.99 % at 0.01 µm	FD	
241	205	177	metal/sight glass	0.5	570	9500	16	50	G1 ¹ / ₄	FD-10MJ
					432	7200	16	5		FD-10MG
241	205	177	metal/sight glass	0.5	600	10000	16	50	G1 ¹ / ₂	FD-1AMJ
					450	7500	16	5		FD-1AMG
215	265	223	metal/sight glass	1.2	1800	30000	16	50	G1 ¹ / ₂	FD-12MJ
				1.2	1380	23000	16	5		FD-12MG
215	265	223	metal/sight glass	1.2	1800	30000	16	50	G2	FD-16MJ
				1.2	1380	23000	16	5		FD-16MG



FD-10/-1A



FD-12/-16

Special options, add the appropriate letter

operating pressure 30 bar	metal bowl w/o sight glass, with manual drain	FD-... N. H
manual drain	max. 16 bar	FD-... H
automatic drain	draining through float valve, max. 16 bar for G ³ / ₈ to G2	FD-... R

Accessories, enclosed

mounting bracket	made of stainless steel	for G ³ / ₈ to G1 ¹ / ₂ (1A)	BW00-59S
	made of steel	for G1 ¹ / ₂ (12) and G2	BW00-61

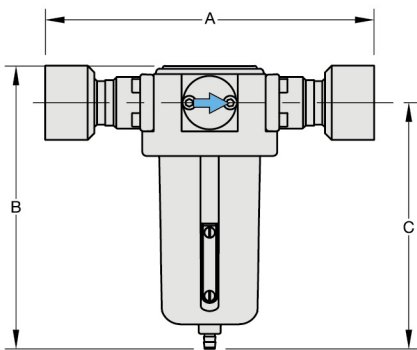

FD-10 /-1A

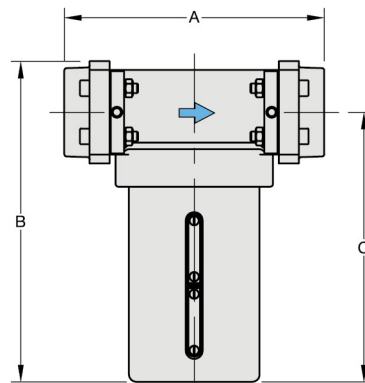

FD-12/-16

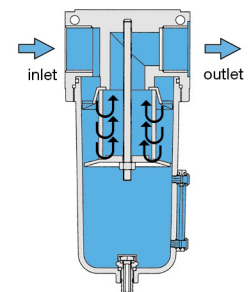

cross-section

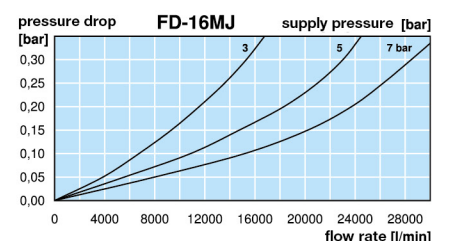
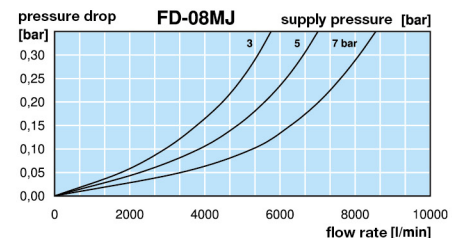

*1 at 7 bar operating pressure and 0.33 bar pressure drop

Extensions: see chapter for FRL service units

PDF CAD
www.aircom.net



Order example:
FD-10MJ

	pre-filter V	Fine filter Z
Description	Coarse filter for removing water and solid impurities.	Filters out oil, water and solid impurities. Resistant to mineral and synthetic oils.
Filter element	3 µm incoming flow from inside to outside.	1 µm incoming flow from inside to outside.
Filtration efficiency	99.99% based on 3 µm particle size	99.9999% at 1 µm particle size, residual oil content ≤ 0.5 mg/m³
Filter change	Cleaning required as from 0.35 bar differential pressure. Solid impurities removed by blowing from inside to outside. Oil to be cleaned in soap suds.	The filter must be changed as from 0.35 bar differential pressure or after one year at the latest.
Drainage	automatic drain as standard, optionally manual drain	
Temperature range	1 °C to 65 °C / 34 °F to 149 °F	
Operating pressure	max. 16 bar	
Material	Body/Bowl: chromated and powder-coated cast aluminium	

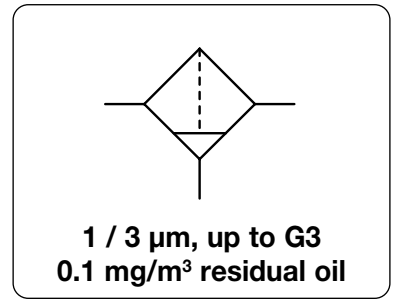

Dimensions			Bowl		Flow rate		Filter element	Connection	Order number
A	B	C	Design	Capacity	m³/h*1	l/min*1	µm	thread	
mm	mm	mm	of / with	l				G	

Micro pre-filter 3 µm					with automatic drain, 99,99% filtration efficiency, max. 16 bar			FG. V	
69	194	173	aluminium /	0.2	30	500	3	G¼	FG-02V
89	293	269	automatic drain	0.8	60	1 000		G¾	FG-03V
89	293	269		0.8	108	1 800		G½	FG-04V
89	293	269		0.8	132	2 200		G¾	FG-A6V
109	393	359		1.8	180	3 000		G¾	FG-06V
109	393	359		1.8	270	4 500		G1	FG-08V
109	540	506		2.7	372	6 200		G1¼	FG-10V
109	540	506		2.7	432	7 200		G1½	FG-1AV
150	576	535		4.9	732	12 200		G1½	FG-12V
150	954	913		8.0	1 050	17 500		G2	FG-16V
188	759	703		10.3	1 800	30 000		G2½	FG-20V
188	939	903		12.7	2 220	37 000		G3	FG-24V



Micro fine filter 1 µm					with automatic drain, 99,9999% filtration efficiency residual oil ≤ 0.1 mg/m³, max. 16 bar			FG. Z	
69	194	173	aluminium /	0.2	30	500	1	G¼	FG-02Z
89	293	269	automatic drain	0.8	60	1 000		G¾	FG-03Z
89	293	269		0.8	108	1 800		G½	FG-04Z
89	293	269		0.8	132	2 200		G¾	FG-A6Z
109	393	359		1.8	180	3 000		G¾	FG-06Z
109	393	359		1.8	270	4 500		G1	FG-08Z
109	540	506		2.7	372	6 200		G1¼	FG-10Z
109	540	506		2.7	432	7 200		G1½	FG-1AZ
150	576	535		4.9	732	12 200		G1½	FG-12Z
150	954	913		8.0	1 050	17 500		G2	FG-16Z
188	759	703		10.3	1 800	30 000		G2½	FG-20Z
188	939	903		12.7	2 220	37 000		G3	FG-24Z



Special options, add the appropriate letter

differential pressure gauge	FG-. . . D
replacement indicator	FG-. . . E
further sizes	

Accessories, enclosed

set of mounting brackets	made of steel	for G¼	BW00-52
		for G¾ to G¾ (A6)	BW00-53
		for G¾ (06) to G1½	BW00-54
		for G1½ (12) and G2	BW00-55
		for G2½ and G3	BW00-56

Flow rate conversion factor for other operating pressures																
operating pressure bar	1	2	3	4	5	6	7	8	9	10	11	12	13	14	15	16
factor	0.25	0.38	0.5	0.65	0.75	0.88	1	1.13	1.25	1.38	1.5	1.63	1.75	1.88	2	2.13

*1 at 7 bar operating pressure and open outlet. Pressure drop in new condition: **20 mbar** on pre-filter and **30 mbar** on universal filter. The maximum permissible flow rate is 10% higher than the indicated value.

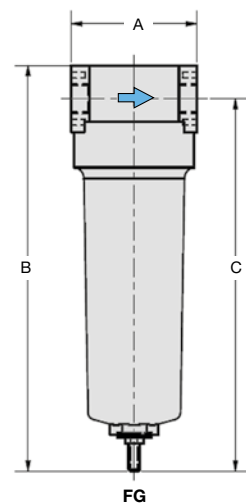

	Super fine filter X	Activated Carbon Filter A
Description	The filter separates oil, water and solid impurities from compressed air or non-corrosive gases. It is resistant to mineral and synthetic oils.	Air filtered with this combination is virtually free from oil and odours.
Filter element	0.01 µm incoming flow from inside to outside	0.01 µm incoming flow from inside to outside
Filtration efficiency	99.99999% based on 0.01 µm particle size residual oil content ≤ 0.01 mg/m ³ at 7 bar and 20 °C/68 °F	residual oil content ≤ 0.03 mg/m ³ bei 7 bar and 20 °C/68 °F
Filter change	Cleaning required as from 0.35 bar differential pressure, at the latest after 3 months.	Cleaning required as from 0.35 bar differential pressure, at the latest after 3 months.
Drainage	automatic drain as standard, optionally manual drain	manual drain as standard
Temperature range	1 °C to 65 °C / 34 °F to 149 °F	1 °C to 30 °C / 34 °F to 86 °F
Operating pressure	max. 16 bar	
Material	Body/Bowl: chromated and powder-coated cast aluminium	

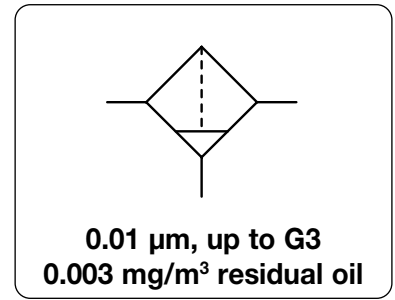

Dimensions			Bowl		Flow rate		Filter element	Connection	Order number
A	B	C	Design	Capacity	m ³ /h*1	l/min*1	µm	thread	G

Super fine filter 0.01 mg/m ³ residual oil							with automatic drain, max. 16 bar 99,99999%, at 0.01 µm	FG. X	
69	194	173	aluminium /	0.2	30	500	0.01	G¼	FG-02X
89	293	269	manual drain	0.8	60	1000		G¾	FG-03X
89	293	269		0.8	108	1800		G½	FG-04X
89	293	269		0.8	132	2200		G¾	FG-A6X
109	393	359		1.8	180	3000		G¾	FG-06X
109	393	359		1.8	270	4500		G1	FG-08X
109	540	506		2.7	372	6200		G1¼	FG-10X
109	540	506		2.7	432	7200		G1½	FG-1AX
150	576	535		4.9	732	12200		G1½	FG-12X
150	954	913		8.0	1050	17500		G2	FG-16X
188	759	703		10.3	1800	30000		G2½	FG-20X
188	939	903		12.7	2220	37000		G3	FG-24X



Activated carbon filter 0.003 mg/m ³ residual oil							with manual drain, max. 16 bar	FG. A	
69	185	164	aluminium /	0.2	30	500	activated carbon	G¼	FG-02A
89	284	260	manual drain	0.8	60	1000		G¾	FG-03A
89	284	260		0.8	108	1800		G½	FG-04A
89	284	260		0.8	132	2200		G¾	FG-A6A
109	384	350		1.8	180	3000		G¾	FG-06A
109	384	350		1.8	270	4500		G1	FG-08A
109	531	497		2.7	372	6200		G1¼	FG-10A
109	531	497		2.7	432	7200		G1½	FG-1AA
150	567	526		4.9	732	12200		G1½	FG-12A
150	945	904		8.0	1050	17500		G2	FG-16A
188	748	694		10.3	1800	30000		G2½	FG-20A
188	930	894		12.7	2220	37000		G3	FG-24A

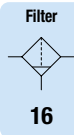

Special options, add the appropriate letter

differential pressure gauge **FG-. . . D**

replacement indicator **FG-. . . E**

further sizes

Accessories, enclosed

set of mounting brackets made of steel

for G¼ **BW00-52**

for G¾ to G¾ (A6) **BW00-53**

for G¾ (06) to G1½ **BW00-54**

for G1½ (12) and G2 **BW00-55**

for G2½ and G3 **BW00-56**

Flow rate conversion factor for other operating pressures																
operating pressure bar	1	2	3	4	5	6	7	8	9	10	11	12	13	14	15	16
factor	0.25	0.38	0.5	0.65	0.75	0.88	1	1.13	1.25	1.38	1.5	1.63	1.75	1.88	2	2.13

*1 at 7 bar operating pressure and open outlet. Pressure drop in new condition: **50 mbar** on fine filter and **90 mbar** on super fine filter. The maximum permissible flow rate is 10% higher than the indicated value.

HIGH PRESSURE FILTER UP TO 60 BAR

F445 / F465

Description	Compressed air filter for up to 60 bar operating pressure with various filter elements. Mounting in horizontal position, flow direction indicated by arrow.
Filter element	5 µm and 40 µm made of sintered bronze, 0.01 µm coalescing filter made of borosilicate fibres with stainless steel jacket and foam protection
Filtration efficiency	coalescing filter: 99.999% based on 0.01 µm particle size
Bowl	metal version without sight glass
Drainage	manual drain as standard
Supply pressure	max. 60 bar
Temperature range	0 °C to 90 °C / 32 °F to 194 °F, for appropriately conditioned compressed air down to -30 °C / -22 °F
Material	Body: black, anodized aluminium Bowl: brass at G $\frac{3}{8}$ to G1, aluminium at G1½ and G2 Elastomer: NBR/Buna-N

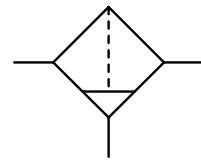

40/60 bar, up to G2
0.01/5/40 µm

Dimensions			Bowl	Flow rate	Filter element	Connection	Order number
A	B	C	Design	Capacity	rate	thread	
mm	mm	mm	made of	l	m ³ /h*1	l/min*1	µm

High pressure filter up to 40 bar								with manual drain, 99.999% at 0.01 µm	F445
72	200	168	metal	0.08	162	2700	40	G $\frac{3}{8}$ " ²	F445-03EL
65	200	168			168	2800		G $\frac{1}{2}$ "	F445-04EL
92	210	170	metal	0.10	198	3300		G $\frac{3}{4}$ " ²	F445-06EL
80	210	170			210	3500		G1"	F445-08EL
150	285	243	metal	0.30	1200	20000		G1½" ²	F445-12EL
140	285	243			1320	22000		G2"	F445-16EL
72	200	168	metal	0.08	126	2100	5	G $\frac{3}{8}$ " ²	F445-03GL
65	200	168			138	2300		G $\frac{1}{2}$ "	F445-04GL
92	210	170	metal	0.10	156	2600		G $\frac{3}{4}$ " ²	F445-06GL
80	210	170			168	2800		G1"	F445-08GL
150	285	243	metal	0.30	900	15000		G1½" ²	F445-12GL
140	285	243			1080	18000		G2"	F445-16GL
72	200	168	metal	0.08	150	2500	0.01	G $\frac{3}{8}$ " ²	F445-03IL
65	200	168			162	2700		G $\frac{1}{2}$ "	F445-04IL
92	210	170	metal	0.10	192	3200		G $\frac{3}{4}$ " ²	F445-06IL
80	210	170			204	3400		G1"	F445-08IL
150	285	243	metal	0.30	1140	19000		G1½" ²	F445-12IL
140	285	243			1260	21000		G2"	F445-16IL



F445-04, 40 bar



F465-08, 60 bar

High pressure filter up to 60 bar								with manual drain, 99.999% at 0.01 µm	F465
72	185	160	metal	0.08	162	2700	40	G $\frac{3}{8}$ " ²	F465-03EL
65	185	160			168	2800		G $\frac{1}{2}$ "	F465-04EL
92	200	170	metal	0.10	198	3300		G $\frac{3}{4}$ " ²	F465-06EL
80	185	160			210	3500		G1"	F465-08EL
72	185	160	metal	0.08	126	2100	5	G $\frac{3}{8}$ " ²	F465-03GL
65	185	160			135	2300		G $\frac{1}{2}$ "	F465-04GL
92	200	170	metal	0.10	156	2600		G $\frac{3}{4}$ " ²	F465-06GL
80	200	170			168	2800		G1"	F465-08GL
72	185	160	metal	0.08	150	2500	0.01	G $\frac{3}{8}$ " ²	F465-03IL
65	185	160			162	2700		G $\frac{1}{2}$ "	F465-04IL
92	200	170	metal	0.10	192	3200		G $\frac{3}{4}$ " ²	F465-06IL
80	200	170			204	3400		G1"	F465-08IL

Special options, add the appropriate letter

for oxygen specially cleaned F4.5-...15

Accessories, enclosed

mounting bracket made of steel

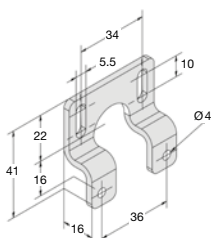

BW00-15

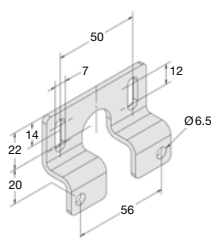

BW00-16

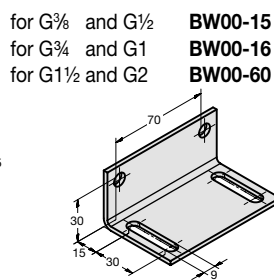

BW00-60

for G $\frac{3}{8}$ " and G $\frac{1}{2}$ " **BW00-15**
for G $\frac{3}{4}$ " and G1" **BW00-16**
for G1½" and G2" **BW00-60**

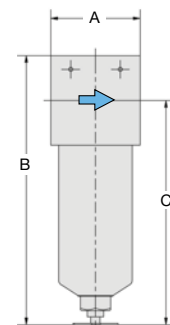

F445 / F465

*1 at 7 bar operating pressure and 0.33 bar pressure drop

*2 reduced from the next bigger filter size

PDF CAD
www.aircom.net



Order example:
F445-03EL

Description The exhaust filter/sound silencer treats all exhaust air issued by pneumatic devices:
 1) Removing environmentally harmful oil particles from oily exhaust air
 2) Silencing exhaust air noise

Filtration efficiency > 99.99%, residual oil content < 0.01 mg/m³

Noise reduction > 40 dB (A) at 1 m

Service life approx. 2500 operating hours, depending on contamination

Drainage The bowl is emptied by means of an overflow valve or by opening the manual drain.

Operating pressure max. 16 bar

Temperature range 2 °C to 100 °C / 36 °F to 212 °F

Material Housing: polypropylene at G¼ and G¾, aluminium at G½ to G2
 Filter: micro fibreglass and polyurethane

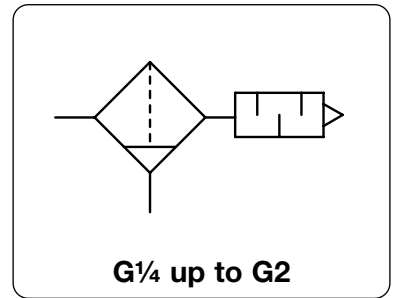

Dimensions				Flow rate	Connection thread	Order number
A	B	ØC	A/F			
mm	mm	mm	mm	m ³ /h*1	G	

Filter silencer				operating pressure max. 16 bar		SFE	
8	131	77	28	30	500	G¼	SFE-02
8	131	77	28	35	580	G¾	SFE-03
12	181	90	36	75	1250	G½	SFE-04
12	181	90	36	100	1670	G¾	SFE-06
15	254	110	50	175	2920	G1	SFE-08
70	287	110	50	200	3330	G1¼	SFE-10
70	312	110	50	200	3330	G1½	SFE-12
70	312	110	50	200	3330	G2	SFE-16



Accessories, enclosed

mounting bracket made of steel

for G¼ to G¾ **BW00-20**

for G1 to G2 **BW00-21**

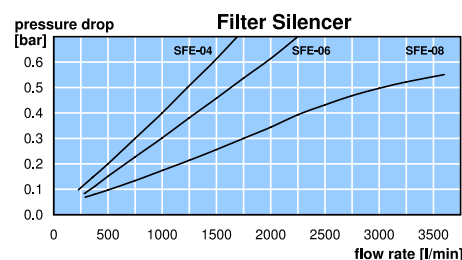
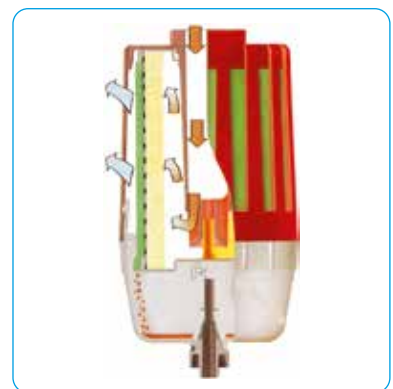
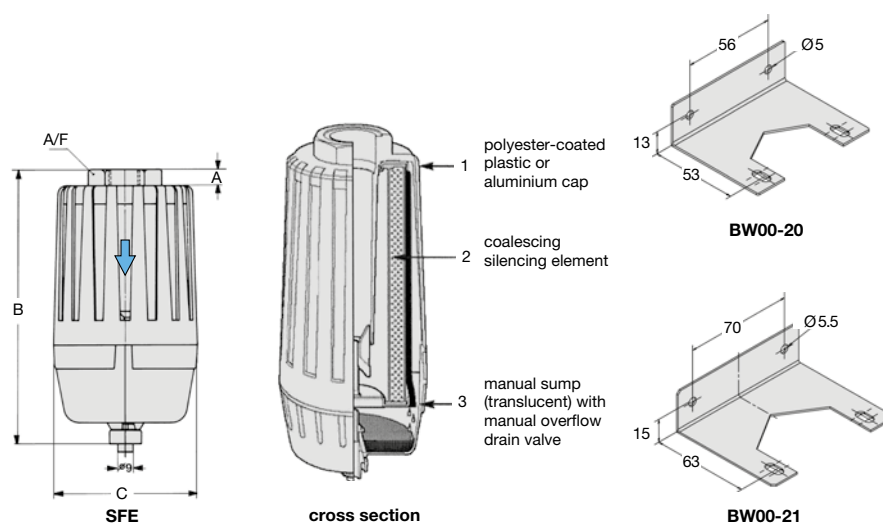

*1 at 6 bar operating pressure to atmosphere